

Mixed Categories as Head Sharing Constructions¹

Joan Bresnan

Stanford University

Proceedings of the LFG97 Conference
University of California, San Diego

Miriam Butt and Tracy Holloway King (Editors)

1997

CSLI Publications

<http://www-csli.stanford.edu/publications/>

¹I am grateful to Yukiko Morimoto, John Mugane, and Louisa Sadler for discussion of the issues in this paper. I have revised the version presented at LFG97 in San Diego, June 21, 1997 prompted by questions and comments from Avery Andrews, Adams Bodom, John Moore, Peter Sells, Andrew Spencer, and Nigel Vincent. I remain responsible for all errors.

The Problem

Mixed categories are constructions in which a single word heads a phrase which is a syntactic hybrid of two different category types. Examples from Italian, Kikuyu, German, and Japanese are given in (1)–(8).

In the examples of the Italian infinitive noun in (1)–(2), determiners, possessive and qualifying adjectives—NP/DP constituents—appear before the infinitive, while direct object NPs and adverbs—VP constituents—appear after the infinitive (Zucchi 1993):

- (1) *il suo continuo momorare parole dolci*
 the his/her continual whisper.INF words sweet
 ‘his continual whispering of soft words’ (Zucchi 1993: 239)
- (2) *il suo scribere quella lettera improvvisamente*
 the his/her write.INF that letter suddenly
 ‘his suddenly writing that letter’ (Zucchi 1993: 54)

Normally nouns take adjectives and not adverbs as modifiers; compare the nominalization in (3):

- (3) *la cessazione improvvisa/*improvvisamente delle ostilità*
 the cessation sudden/suddenly of the hostilities
 ‘the sudden cessation of the hostilities’ (Zucchi 1993: 223)

The *infinito sostantivato* shows its mixed properties in being able to take both adjectives and adverbs at the same time:

- (4) *il suo continuo eseguire la canzone impeccabilmente*
 the his/her continual perform.INF the song impeccably
 (Zucchi 1993: 55)

In the Kikuyu examples (5)–(6), the mixed category consists of an agentive nominalization, immediately followed by VP constituents such as direct and applied object NPs and adverbs, which can be followed in turn by NP/DP constituents such as determiners and adjectives (Mugane 1996).

- (5) a. *mũ-thĩĩnj-i mbũri ũyũ*
 CL1-slaughter-NOM CL10.goat CL1.DEM
 ‘this goat slaughterer’ (Mugane 1996: 103)
- b. *mũ-thĩĩnj-ir-i a-ndũ mbũri wega*
 CL1-slaughter-APPLIC-NOM CL2-people CL10.goat well
 ‘one who slaughters goats for people well’ (Mugane 1996: 106)

Outside of mixed constructions, Kikuyu nouns do not take NP complements and adverbs, and verbs do not take the nominal class marking morphology, determiners and adjectives of (Mugane 1996).

The German adjectival participle is shown in prenominal position modifying the NP in (6a,b) (Drijkoningen 1992):

- (6) a. *ein mehrere Sprachen sprechender Mann*
 a several languages speaking.M.SG.NOM man.M.SG

- b. *einen mehrere Sprachen sprechenden Mann*
 a.acc several languages speaking.M.SG.ACC man.M.SG
 ‘a man speaking several languages’ (Drijkoningen 1992: 55)

The participle takes adjectival agreement morphology; compare (7a,b):

- (7) a. *ein kleiner Mann*
 a little.M.SG.NOM man.M.SG
- b. *einen kleinen Mann*
 a.ACC little.M.SG.NOM man.M.SG
 ‘a little man’

Adnominal adjectives in German agree in number and case but not person, while verbs agree in person and number, but not case. Thus the participle is an adjective with the complements and modifiers of a verb.

In the Japanese mixed category construction of (8) (Morimoto 1996), a verbalized nominalization can have either nominal or verbal complements and modifiers, or both. Thus in (8), the nominative case-marked NP is a verbal subject argument, while the genitive case-marked NP is a nominal object argument.

- (8) *taroo-ga kinmedaru-no morai-ta-sa-no amari,...*
 Taro-NOM gold.medal-GEN receive-want-NOMINALIZER-COP excess
 ‘out of Taro’s desire to get a gold medal,...’ (Morimoto 1996: 19)

Mixed categories are very common crosslinguistically. They are problematic for syntactic theory because phrases of different categories appear to be projected simultaneously by the same head, raising questions about the universal structure of categories and the relation of morphology to syntax. They challenge the principles of phrasal endocentricity (Does every category have a head?) and lexical integrity (Can morphemes separately belong to different categories in the syntax and then be joined together into a single surface word?).

The Indeterminate Category Projection Theory

One approach to the problem of mixed categories is to assume that the head is lexically indeterminate (underspecified, bivalent, or neutral) for its category and projects an indeterminate phrasal structure which may contain constituents of mixed types (Aoun 1981, van Riemsdijk 1983, Grimshaw 1991, Malouf 1997, among others). An argument in favor of this approach is that in many languages mixed category constructions are headed by words which appear to be morphologically ambiguous or neutral between the two categories of the mixed construction; the Italian infinitival noun is an example, being either a nominal or a verbal form. On this account, the mixed category properties of the construction follow by endocentricity from the categorial indeterminacy of the heads.

There are two problems with this approach, however. First, category neutrality of the head is *not* a universal feature of mixed category constructions. The heads of the mixed categories in the Kikuyu, German, and Japanese examples in (5)–(8) are morphologically unambiguous. For example, the Kikuyu nominalization is a noun bearing a noun class prefix and a nominalizing suffix; the German participle is morphologically an adjective. Elsewhere categorial unambiguity of the head appears in Quechua nominalization-headed clauses (Lefebvre and Muysken 1988), Arabic

deverbal process nominals or *mašdars* (Fassi Fehri 1993), Hebrew action nominalizations (Hazout 1995), and Dagaare action nominalizations (Bresnan and Bodomo 1997).

The second problem with this approach is that phrasal coherence constrains the mixing of categories: the hybrid construction can be partitioned into two categorially uniform subtrees such that one is embedded as a constituent of the other.² Phrasal coherence characterizes all of the examples given in (1)–(8), as illustrated in diagrams (9)–(12).

Diagram (9) shows that the verbal constituents in the Italian examples are embedded as a coherent unit dominated by VP on the right branch of the nominal constituents; the head infinitive is shown as shared by both phrases in an intuitive sense to be made precise below.

(9) Italian:

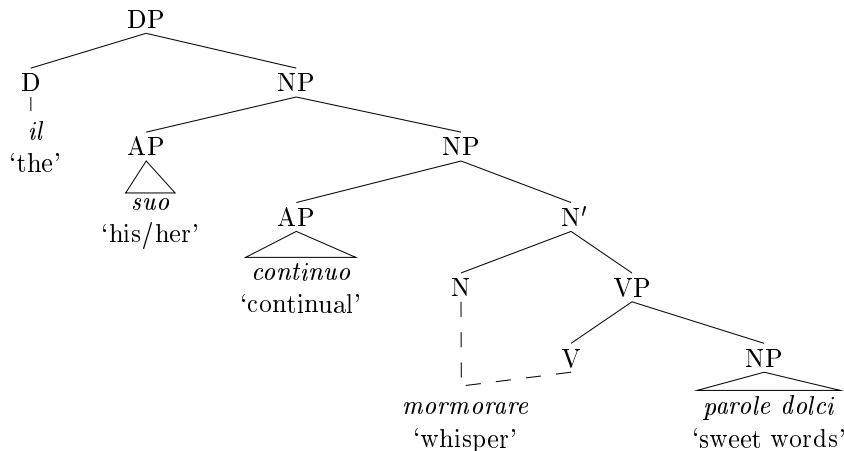
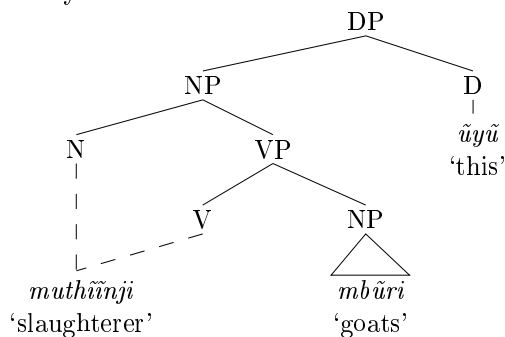

Diagram (10) shows that in Kikuyu as in Italian the mixed category can be analyzed as a VP embedded in an NP. Except for the head, the VP material coheres inside the NP as a single verbal constituent.

(10) Kikuyu:



The analysis in (10) is due to Mugane 1996, except that here the head of the mixed category—though it is unambiguously a morphological N—is again depicted intuitively as shared between the VP and NP.

Diagram (11) illustrates the same point for the German examples: the verbal parts of the construction appear embedded as though part of a VP within an AP. Again the head is shown shared between AP and VP, though it is unambiguously a morphological A.

²Phrasal coherence' is the apt term used by Malouf 1997, although he argues that the property does not universally characterize mixed category constructions, for reasons discussed below.

(11) German:

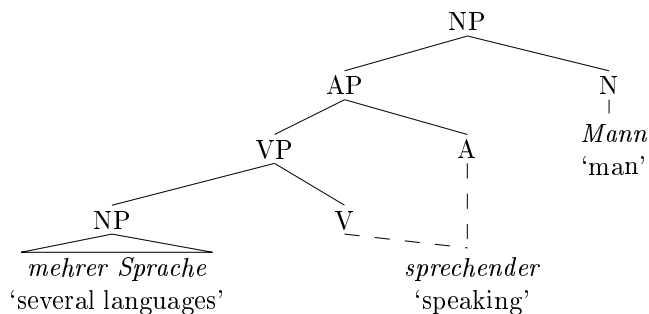
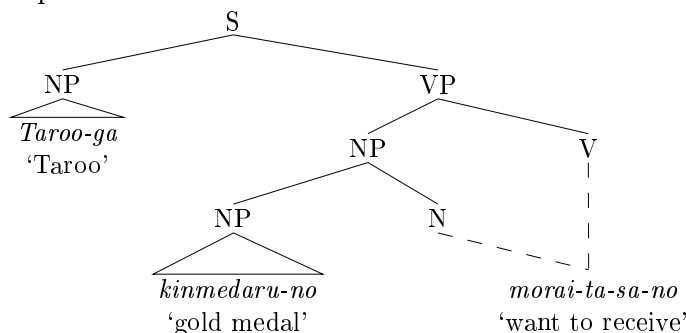

Diagram (12) shows the phrasal coherence of the Japanese construction, following an analysis suggested by Morimoto 1996 but represented here in slightly modified form:

(12) Japanese:



Again we see phrasal coherence of the verbal and the nominal parts of the mixed categories.

What we do not find in mixed category constructions is free mixing or interleaving of constituents of different categories. The constraints on the construction are consistent with phrasal coherence. For example, Zucchi (1993: chs. 2, 7) establishes the generalizations that in the Italian *infinito sostantivato*, the constituents preceding the infinitive are always nominal (determiners and adjectives), while following the infinitive a uniform choice must be made between VP constituents (such as direct objects and adverbs) or NP constituents (such as a postnominal adjectival and *di* phrase). Examples (13a–c) from Zucchi (1993: 222) illustrate this generalization:³

- (13) a. *il mormorare somnesso/*sommessamente del mare*
 the whisper.INF soft/softly of.the sea
 'the soft whispering of the sea' (Zucchi 1993: 220)
- b. *il suo mormorare somnessamente*
 the his/her whisper.INF softly
 'his/her whispering softly' (Zucchi 1993: 226)
- c. *il suo mormorare continuamente/*continuo parole dolci*
 the his/her whisper.INF continually/continual sweet words
 [compare to (1)] (Zucchi 1993: 245)

³The adverb in example (13c) is implied to be grammatical but not given explicitly by Zucchi; Rodolfo Delmonte (p.c. July 1997) has kindly confirmed the judgments shown.

Similarly, Mugane 1996 argues that the concordial DP constituents of Kikuyu (determiners, possessors, and adnominal modifiers) must appear outside of the verbal complement and adverb structures as shown in (10). Likewise, Morimoto (1996: 11) argues that in the Japanese verbalized nominalized constructions, the nominal complements and modifiers, which are case-marked genitive, must follow the complements and modifiers which bear verbal case marking.

This is not to say that categorially different constituent types cannot be interspersed—the Kikuyu examples show that this can happen with verbal constituents separating nominal constituents, and the Japanese examples show the opposite possibility of nominal constituents separating verbal constituents. But the interspersing shows strong phrasal coherence constraints as implied by the structures in (9)–(12). The constraints on category mixture are just those of phrases of different determinate category types being embedded in one another in the normal ways but—abnormally—sharing a single head. On the categorial indeterminacy theories the two categories are instead folded together and overlaid as a single, indeterminate endocentric projection of a categorially indeterminate head. The coherent regions of categorial determinacy are then unexplained.

Head-Sharing Theories

The problem now is how to capture formally the head-sharing analysis intuitively depicted above. It is this which allows the phrasal coherence property to be explained. Three general lines of approach are available:

- (14) a. morphological derivation in syntax
- b. projection-switching: phrase-structure projection of two different categories from a single lexical head
- c. extended head theory: different categories share the same head in f-structure, not c-structure

Morphological derivation in syntax (14a) has been repeatedly employed within transformational frameworks to capture the syntactic properties of mixed categories, beginning with the work of Lees 1963 and extending to recent works by Baker 1985, Drijkoningen 1992, Hazout 1995, Borsley and Kornfilt 1996, and others. The general approach is illustrated in diagram (15), which depicts a Kikuyu-like structure:⁴

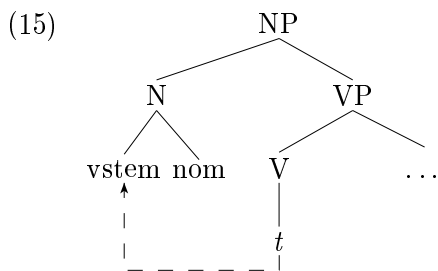

The verb stem is generated as the head of a VP selected by an abstract nominalization morpheme heading an NP. The morphological pieces of the deverbal nominalization are joined together transformationally, by head-movement in (15) (and by affix-movement in earlier accounts).

⁴The theories vary in detail; for example, Borsley and Kornfilt 1996 only allow category-crossing head movement from verbal categories into nominal functional projections.

Although the approach rather elegantly captures both the endocentricity and the phrasal coherence of mixed categories, its weakness lies in failing to explain the relations between lexically and syntactically derived words. The putative syntactically derived words are subject to the same morphological principles of structural formation as lexically derived words, and they both share properties of syntactic structural opacity referred to as ‘lexical integrity’ (see Bresnan and Mchombo 1995 for a recent review). For example, in Bantu the heads of phrases (verbs or nouns) can be syntactically conjoined; why then do conjoined verb stems, if they are syntactic heads, never undergo nominalization by head movement? Examples like (16) are as bad in Kikuyu, which allows mixed categories, as in Chichewa, which does not (Bresnan and Mchombo 1995):⁵

- (16) * *mũ-[thĩĩnj-na-rug]-i* *mbũri* *ũũru*
 CL1-slaughter-and-cook-NOM CL10.goat badly
 Lit.: ‘a slaughter-and-cook-er goats badly’

Similarly, syntactic categories can be omitted by ellipsis or extraction gaps, which depend for their meaning on the wider syntactic context; why then do nominalizations never include such empty categories? It is unexplained why the putative syntactically derived words should behave exactly like lexically derived words in these respects. These and other properties are explained by modern lexicalist theories of syntax, which rely on argument structure (and in the case of LFG f-structure) rather than phrase structure to capture generalizations across morphology and syntax.

A lexicalist approach to head-sharing has been developed using the idea of category-switching projection or double projection from a single lexical head (14b). For example, Lefebvre and Muysken 1988 analyze Quechua clauses as verbal projections from a nominal projection headed by a nominalized verb. They present an X' schema that allows the projection from such a nominalized head to switch categories at a certain level (N'). Lapointe's 1993 theory of dual category projection from a single head is similar in conception, but allows the category switching at the maximal projection level. It is illustrated for a Kikuyu-like structure in (17):

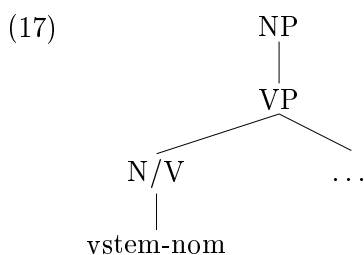

In (17) the nominalized verb is lexically assigned a dual category N/V which syntactically projects up to a maximal verbal projection VP and then further on up to a maximal nominal projection NP. Morimoto 1996 shows how Lapointe's theory can be applied to the verbalized nominalization constructions in Japanese, which would be lexically assigned the dual category V/N rather than N/V and would switch projections at the X' level. All of these versions of the projection-switching theory are explicitly lexicalist, and hence they are compatible with most current surface-oriented nonderivational frameworks.

The theory of category-switching projection nevertheless has a major empirical weakness. Because the head projects upwards, switching category types (e.g. from verbal to nominal or vice versa) along the way, the theory entails that that the head is positioned in the most deeply embedded of the projections. In contrast, the head-movement theory of morphological derivation unequivocally

⁵Example (16) was kindly provided by John Mugane in personal communication, July 1997.

positions the head in the upper projection, vacating the lowest head position. In the examples of mixed categories we have considered up to now, the head positions of the mixed categories have been adjacent in the tree, so we cannot readily tell whether it is the upper or the lower head position that is filled. But mixed category constructions in other languages exhibit head-sharing between nonadjacent positions in the tree. Examples occur in Arabic (Fassi-Fehri 1993), Hebrew (Hazout 1995), and in Dagaare, a Gur language (Niger-Congo) of West Africa (Bresnan and Bodomo 1997):

- (18) Arabic (Fassi-Fehri 1993: 247):
salb-u zayd-in r-rajul-i maal-a-hu
 depriving-NOM Zayd-GEN the-man-ACC money-ACC-his
 ‘Zayd’s depriving the man of his money.’
- (19) Hebrew (Hazout 1995: 365):
axilat ha-yeled et ha-tapuaʔ bi-mehirut
 eating the-boy ACC the-apple quickly
 ‘the boy’s eating the apple quickly’
- (20) Dagaare (Bresnan and Bodomo 1997):
a Dere ga-ma wiewie velaa sɔr-oo nyɛ
 DEF NAME book-PL quickly good read-NOM this
 ‘This nice way of Dere’s reading books quickly.’

As Fassi-Fehri (1993: ch. 5) shows, the basic structure of nominal phrases in Arabic is N Specifier Complement, with the genitive Specifier following the head noun in the construct state construction. When the head is a nominalized verb, the genitive construct state construction remains, but the complement may consist of VP constituents such as accusative objects and adverbs. This is what we see in (18): N, Specifier of NP, Complements of VP. Note that the head position within the VP (immediately following the genitive NP) is vacant, while the upper head position of the nominal phrase (initial to the whole phrase) is occupied by the nominalization. Thus this structure is incompatible with the projection-switching theory. The Hebrew action nominalization is very similar to that of Arabic (Hazout 1995). Again the basic structure of the NP is NSO (Ritter 1986, 1988, 1991), or Noun Specifier Complement; the action nominalization allows for the complement to consist of VP constituents minus the head V, with the head appearing phrase-initially in the N position before the genitive.

The structure of the Dagaare nominalization (20) according to Bresnan and Bodomo 1997 is shown in (21):⁶

⁶Another possible structure has S as the sister to the lower N', containing both the subject *Dere* and the headless VP.

(21)

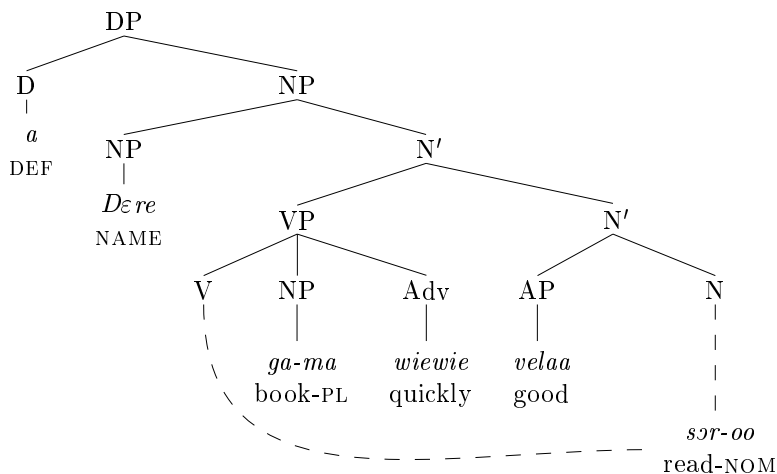

In Dagaare nominals, any argument of a noun must precede it, while the verb's complements follow it in finite clauses. This structural difference allows us to determine that the nominalized verbal head of the construction in (21) is in the head position of the upper NP projection, rather than in that of the lower VP projection.

One could counter this kind of evidence by proposing an alternative analysis of the constructions that does not preserve the phrasal coherence property.⁷ For example, instead of (21), one could propose (22), which has only a single head position from which all of the dependents of various types are projected. The projecting category and its projections are of a category type Verbal Noun that shares features of both Verb and Noun, but cannot be identified with either.

(22)

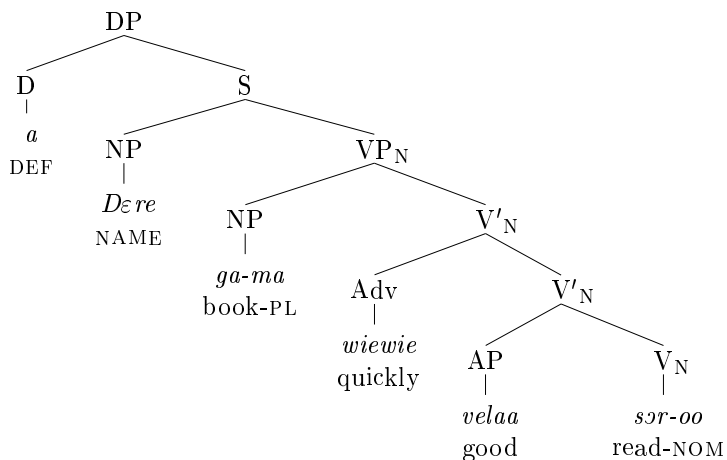

These analyses are empirically distinguishable. The head-sharing analysis (21) predicts that the adverb coheres with the object NP to its left as part of a constituent VP, while the alternative analysis (22) predicts that the adverb does not cohere with the object on the left, but with the nominal constituent to its right. Interestingly, a conjunction of two Object and Adverb sequences is possible within the same NP, while a conjunction of two Adverb and Nominalization sequences is not, as illustrated in (23a,b) from Bresnan and Bodomo 1997:

⁷Malouf 1997 does this for Arabic.

- (23) a. *a* [daa wiewie] ne [koɔ gborɔgborɔ] nyu-u
 DEF beer quickly and water frequently drink-NOM
 Lit.: ‘the drinking beer quickly and water frequently’
- b. **a* daa [wiewie nyu-u] ne [gborɔgborɔ dog-oo]
 DEF beer quickly drink-NOM and frequently brew-NOM
 Lit.: ‘the drinking quickly and brewing frequently beer’

If only constituents can be conjoined,⁸ these facts favor the head-sharing analysis (21) over alternative (22). Thus in (23a) we see the hypothesized headless VP of (21) behaving as a constituent, confirming (21).

In sum, it appears that all of the previous approaches to mixed categories have serious weaknesses: the categorial indeterminacy approach cannot explain the phrasal coherence of mixed categories, though the head-sharing approaches can. But previous head-sharing approaches are deficient in mutually complementary ways. Morphological derivation in syntax can account for the positioning of the shared head, but does not explain the structural integrity common to lexically and syntactically derived words, while the projection-switching approach can explain the lexical integrity properties but not head positioning.

This brings us finally to the extended head theory of LFG (14c), in which different categories share the same head in f-structure, not c-structure. Like other lexicalist frameworks, LFG is incompatible with morphological derivation in syntax because of its lexical integrity principle (see, e.g., Simpson 1991, Bresnan and Mchombo 1995, T. Mohanan 1995, Sells 1995, Cho and Sells 1995, Niño 1995)—

- (24) Relativized lexical integrity:
 Morphologically complete words are leaves of the c-structure tree and each leaf corresponds to one and only one c-structure node.

—and because of the absence of serial derivational mechanisms from its formal architecture. Instead LFG has correspondences between parallel information structures—the c-structure, representing overt forms of expression, and the f-structure, representing equivalence classes of c-structures. If two c-structure categories, one headed and one headless, are mapped into the same f-structure, the alternative head positions are functionally equivalent; it appears as though the head has moved from one category to the other.

The essentials of the extended head theory are given in (25):⁹

⁸ Apparent conjunction of nonconstituents can be explained by peripheral ellipsis from larger conjoined constituents (Bresnan and Thráinsson 1990).

⁹ (25i) derives from work on head movement phenomena in LFG (Netter and Kärcher 1986, Netter 1988, Meier 1992, Frank and Kärcher-Momma 1992, Kroeger 1993, King 1995, Berman and Frank 1996, Bresnan 1996b), and it has been shown to generalize beyond movement to cases of multiple exponence on discontinuous lexically filled head positions (Niño 1995, Bresnan and Nordlinger 1996), because the basic mechanism is not movement, but identification of f-structures through unification. (25ii) derives from the idea (M. Jar n.d., Zaenen and Kaplan (1995: 221–2), Bresnan 1996a,b,c, Sadler 1997) that the head of a phrase missing from its endocentric position can be identified by the inverse mapping of the c-structure to f-structure correspondence (ϕ^{-1}). The restriction of (25ii) to lexical categories is to account for the freer omissibility of heads of closed-class functional categories (DP, CP, ...) whose featural contents are highly restricted and hence recoverable.

(25) **Extended Head Theory:**

- (i) A functional category F^0 and its sister correspond to the same f-structure.
 (Functional heads F^0 are specialized subclasses of lexical heads which have a syncategorematic role in the grammar, such as marking subordination, clause type, or finiteness.)
- (ii) Every lexical category has a(n extended) head.
 (X is an **extended head** of Y if X corresponds to the same f-structure as Y , X is of the same/nondistinct category type as Y , and every node other than Y that dominates X also dominates Y .)

Although verb movement (that is, the variable positioning of verbal heads) may initially seem remote from mixed category phenomena, there are connections. Consider the case of verb ‘movement’ in Welsh. In Welsh, the finite verb is clause-initial, yielding $V_{fin}SO$ word order. However, the SVO order appears when V is a ‘verbal noun’, a nonfinite verbal complement to a finite auxiliary verb which occupies the clause-initial position: $Aux_{fin}SV_nO$. These alternative orders are illustrated by (26a,b) from Sproat (1985: 176):

- (26) a. *Gwnaeth Siôn weld draig.*
 do-3.SG.PAST John see.VN dragon
 ‘John saw a dragon.’
- b. *Gwelodd Siôn draig.*
 saw-3.SG.PAST John dragon
 ‘John saw a dragon.’

A widespread analysis of this alternation is that the finite verb occupies the I position in (27), while the verbal noun occupies the V_N position in VP, following the subject (Sproat 1985). Thus (26a) would have the structure in (27) and (26b) would have the structure in (28):

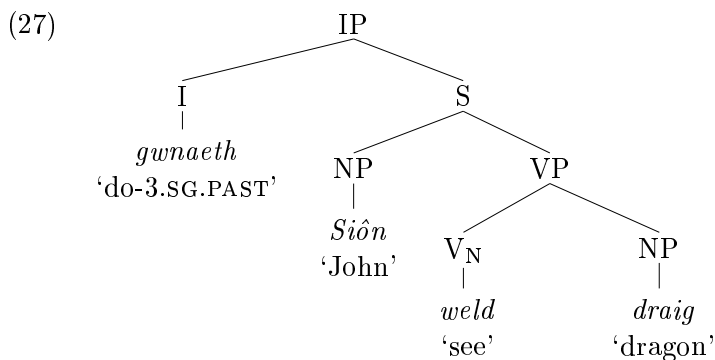

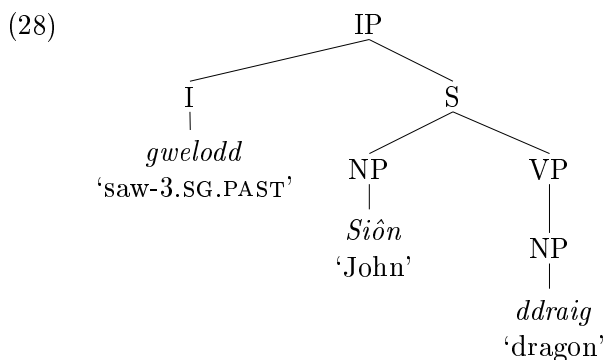

In both situations the finite verb occupies the higher position in the clause, heading the IP and preceding the subject; the nonfinite verb, when present, occupies the lower projection following the subject.¹⁰

An LFG theory of this verb positioning generalization in Welsh is illustrated in (29)–(32) (Kroeger 1993, Bresnan 1996b, Sadler 1997). The finite verb ‘saw’ is based on the inflecting stem *gwel-*; the rules of Welsh inflectional morphology produce the lexical form in (29) for lexical insertion into an I:

- (29) *gwelodd*: I (↑ PRED) = ‘see $\langle x, y \rangle$ ’
 (↑ TENSE) = PAST
 ...

In contrast, the verbal noun form, which is not inflected for tense and agreement, fills the V_N position (30). Both I and V_N are verbal c-structure categories of morphologically complete words; I is the lexical category of finite verbs and V_N the lexical category of verbal nouns.

- (30) *weld*: V_N (↑ PRED) = ‘see $\langle x, y \rangle$ ’

The auxiliary verb *gwnaeth* ‘did’ in I serves merely as a tense and agreement carrier without the PRED attribute to conflict with that of the V_N in VP. All of these morphologically complete verbal heads are thus directly generated in their surface positions in (27) and (28).

Though the finite lexical verb in Welsh is separated from its complements in c-structure (28), it is united with them in the f-structure, thanks to the extended head theory (25). The crucial point is that the functional category I and its sister category S are mapped into the same f-structure. This is represented by the ‘↑ = ↓’ annotations on these nodes in both (31) and (32):¹¹

¹⁰Movement theories postulate a trace of the verbal noun in the position of the head of the VP, not shown in (28).

¹¹Other principles of endocentric structure-function association entail the other annotations; see Bresnan 1996b for details.

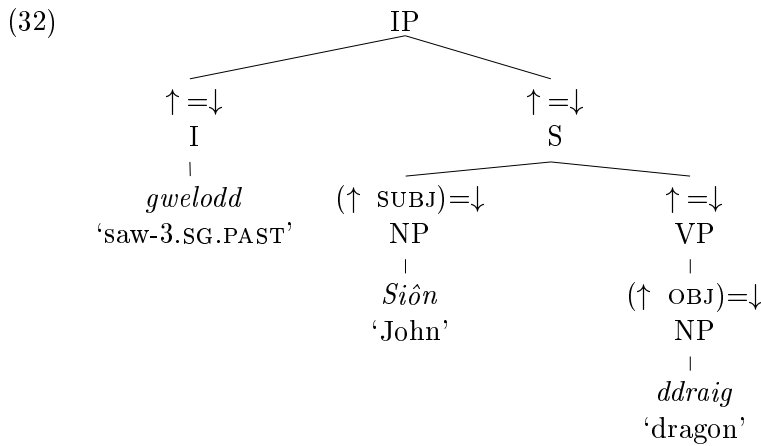
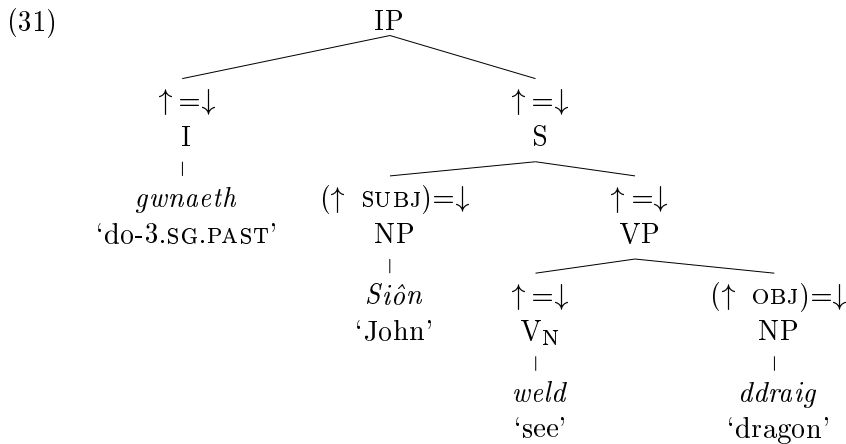

By transitivity of identity, the f-structures of I, IP, S, and VP become identified. Hence, the finite verb of (32) provides the predicator of the VP in f-structure:

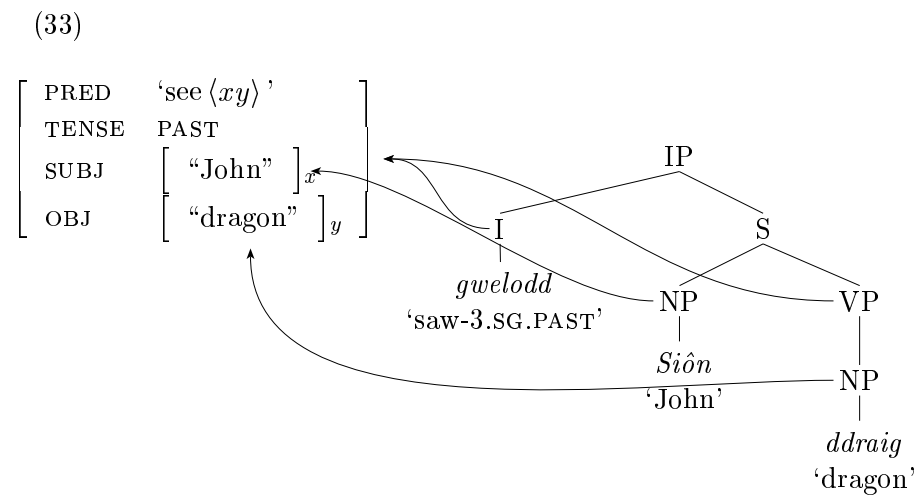

In (33) the finite verb is the extended head of the VP: by (25ii) I is mapped into the same f-structure as the VP, it is of similar category type, and every node that dominates it also dominates VP. In the same way, the finite auxiliary in (31) is also an extended head of its VP, for (31) is

functionally equivalent to (33), having the same f-structure. In (31) both head positions for IP and VP are lexically filled, but the tense and lexical predicator, which are combined into one word in (33), are distributed across two heads in (31). Jointly, then, the two heads in (31) are functionally equivalent to the single finite head in (33).

Now the nonfinite verb in Welsh historically derives from a verbal noun and still retains some nominal properties; for example, pronominal objects of the nonfinite verb appear as a possessive clitic on the verbal noun (Sproat 1985: 183, Sadler 1997). Thus under the above analysis, many Welsh finite clauses may themselves be instances of mixed category constructions, historically at least.

To generalize the extended head theory to mixed categories, we first generalize (25i) to allow the sisters of lexical as well as functional heads to correspond to the head's f-structure (as independently proposed by Alsina 1996 and Sadler 1997). Secondly, we broaden the categorial identity/nondistinctness restriction in (25ii) on the definition of extended head, to allow the extended head X to be a morphological derivative of a category identical/nondistinct from the phrase Y . A nominalized verb can then serve as an extended head of a VP, as in Mugane's 1996 analysis of the Kikuyu mixed categories; a verbalized nominalization can serve as an extended head of an NP, as in Morimoto's 1996 analysis of the Japanese mixed categories. Similarly, an adjectivalized verb can serve as an extended head of a VP as in our German examples (Benke 1996), and an infinitival noun can be an extended head of a VP, as in the Italian *infinito sostantivato*.

The resulting analysis of the Kikuyu-like structure discussed above is illustrated schematically in (34):

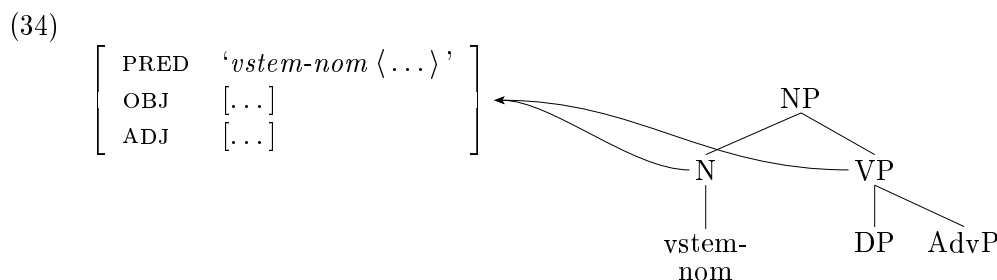

In (34) the f-structures of the N and VP are identified through unification as permitted by the extended head theory (25), allowing the head N (which is a nominalized verb) to provide the predicator (PRED) of the VP f-structure and the VP to provide the object (OBJ) and adverbial adjunct (ADJ) for the N f-structure. Of course, not every nominalized verb will be able to serve simultaneously as a VP and NP predicator. In Kikuyu, we find that agentive and other nominalizations can head mixed categories, while infinitive nouns cannot (Mugane 1996); in Italian it is the reverse (Zucchi 1993). We are thus faced with the question of how the lexical morphology selects a mixed category construction on this theory.

In general, the heads of mixed categories will have to accept both the f-structure attributes of verbal constructions (objects, accusative case, adverbial adjuncts, etc.) and the f-structure attributes of nominal or adjectival constructions (definiteness, genitive case, attributive modifiers, etc.) Since the head provides the PRED for the f-structure and its value is the argument structure, this task of selection of appropriate attributes will fall to the argument structure. Spencer's 1997 theory of argument structure suggests how this can be done in a very natural way.

On Spencer's 1997 theory the argument structure of the verb carries an eventuality variable E in addition to its participant argument roles x, y ; noun argument structures lack an eventuality variable, but possess a referential argument R , and the argument structures of adjectives and other

categories are similarly distinguished. Each argument structure type is associated with functional features characteristic of the category, as illustrated in part in (35) (Spencer 1997).

- (35) a. $verb < E : x, y > \Rightarrow [TNS, ASP, \dots], [AGR], [NOM, ACC]$
 b. $noun < R > \Rightarrow [NMB], [CASE]$

Spencer suggests (p.c. June 1997) that mixed selectional properties of morphologically complex words can follow from the composition of different types of argument structure by lexical word formation processes. For example, we might represent the argument structure of the Kikuyu agentive nominalization as in (36b), where the referential nominal argument binds the agentive participant argument of the verb, leaving the verbal eventuality argument intact (and thus able to accept adverbial modifiers, etc.):

- (36) agentive nominalization based on $verb < E : x, y >$:
 (a) non-mixed-category type (e.g. English): $< R(x), y >$
 (b) mixed-category type (e.g. Kikuyu): $< R(x), < E : x, y >>$

Thus, the lexical morphology of a language must provide the resources to support mixed categories in the syntax by selecting appropriate f-structure attributes, and a suitable theory of argument structure will solve the selection problem for us. But argument structure alone will not suffice to solve the syntactic problems of phrasal coherence, endocentricity, and head positioning that we have noted. These problems yield to a lexicalist syntactic theory of mixed categories as head-sharing constructions, such as we have in the extended head theory of LFG.

References

- Alsina, Alex. 1996. *The Role of Argument Structure in Grammar. Evidence from Romance*. Stanford, California: CSLI Publications.
- Aoun, Yosef. 1981. Parts of speech: a case of redistribution. In *Theory of Markedness in Generative Grammar*, edited by Adriana Belletti, Luciana Brandi, and Luigi Rizzi, 3–24. Pisa: Scuola Normale Superiore di Pisa.
- Baker, Mark. 1985. Syntactic affixation and English gerunds. *Proceedings of the West Coast Conference on Formal Linguistics*, Vol. 4, ed. by Jeffrey Goldberg, Susannah MacKaye, and Michael T. Wescoat, 1–11. Stanford, California: CSLI Publications.
- Benke, Gertraud. 1996. German adjectival participles. Stanford, California: Stanford University School of Education MS.
- Berman, Judith and Anette Frank. 1996. *Deutsche and französische Syntax im Formalismus der LFG*. Tübingen: May Niemeyer Verlag.
- Borsley, Robert and Jaklin Kornfilt. 1996. Mixed extended projections. Paper presented at the International Conference on Syntactic Categories, University of Wales, Bangor, June 24–26, 1996. Bangor: University of Wales Department of Linguistics MS.
- Bresnan, Joan. 1996a. Optimal syntax: Notes on projection, heads, and Optimality. On-line, Stanford University: <http://www-csli.stanford.edu/users/bresnan/download.html>.

- Bresnan, Joan. 1996b. *Lexical Functional Syntax*. Stanford, California: Stanford University Department of Linguistics duplicated MS.
- Bresnan, Joan and Adams Bodomo. 1997. A note on Dagaare action nominalizations as mixed categories. Stanford, California: Stanford University Department of Linguistics MS.
- Bresnan, Joan and Samuel A. Mchombo. 1995. The Lexical Integrity Principle: Evidence from Bantu. *Natural Language & Linguistic Theory* 13.181–252.
- Bresnan, Joan and Höskuldur Thráinsson. 1990. A note on Icelandic coordination. *Syntax and Semantics. Vol. 24: Modern Icelandic Syntax*, ed. by Joan Maling and Annie Zaenen, 355–65. San Diego, California: Academic Press.
- Cho, Young-mee Yu and Peter Sells. 1995. A lexical account of inflectional suffixes in Korean. *Journal of East Asian Linguistics* 4.119–74.
- Drijkoningen, Frank. 1992. Derivation in syntax. In *Morphology Now*, ed. by Mark Aronoff, 48–68. Albany, New York: SUNY Press.
- Fassi Fehri, Abdelkader. 1993. *Issues in the Structure of Arabic Clauses and Words*. Dordrecht: Kluwer.
- Frank, Anette and Ursula Kärcher-Momma. 1992. *Dokumentation zur Französischen Syntax im Formalismus der Lexical Functional Grammar (LFG)*. Stuttgart: Institut für Maschinelle Sprachverarbeitung, University of Stuttgart.
- Grimshaw, Jane. 1991. Extended projection. Waltham, Massachusetts: Brandeis University Linguistics and Cognitive Science Program MS.
- Hazout, Ilan. 1995. Action nominalizations and the Lexicalist Hypothesis. *Natural Language & Linguistic Theory* 13.355–404.
- Jar, M. [John Maxwell III, Annie Zaenen, Ronald M. Kaplan, and Mary Dalrymple]. n.d. Reconstituted X' constituents in LFG. Palo Alto, CA: Xerox Palo Alto Research Center duplicated MS.
- King, Tracy Holloway. 1995. *Configuring Topic and Focus in Russian*. Stanford, California: CSLI Publications.
- Kroeger, Paul. 1993. *Phrase Structure and Grammatical Relations in Tagalog*. Stanford: CSLI Publications.
- Lapointe, Steven. 1993. Dual lexical categories and the syntax of mixed category phrases. *Proceedings of the Tenth Eastern States Conference on Linguistics*, 199–210.
- Lees, Robert B. 1963. *The Grammar of English Nominalizations*. Bloomington, Indiana and The Hague: Indiana University and Mouton.
- Lefebvre, Claire and Pieter Muysken. 1988. *Mixed Categories. Nominalizations in Quechua*. Dordrecht: Kluwer.
- Malouf, Rob. 1997. Mixed categories in the hierarchical lexicon. Stanford University Department of Linguistics Colloquium, June 6, 1997.
- Meier, Judith. 1992. *Eine Grammatik des Deutschen im Formalismus der Lexical Functional Grammar (LFG) unter Berücksichtigung funktionaler Kategorien*. Stuttgart: Institut für Maschinelle Sprachverarbeitung, University of Stuttgart.

- Mohanan, Tara. (1995). "Wordhood and Lexicality: Noun Incorporation in Hindi." *Natural Language & Linguistic Theory* 13, 75–134.
- Morimoto, Yukiko. 1996. Nominalization or verbalization?: analyzing mixed case marking in Japanese. Stanford, California: Stanford University Department of Linguistics MS. [Dec. 16, 1996 version]
- Mugane, John. 1996. *Bantu Nominalization Structures*. Tucson, Arizona: University of Arizona Department of Linguistics doctoral dissertation.
- Netter, Klaus. 1988. Syntactic aspects of LFG-based dialogue parsing. ESPRIT ACORD project 393, Deliverable Task 2.7(a). Stuttgart: Institut für Maschinelle Sprachverarbeitung, University of Stuttgart.
- Netter, Klaus and Ursula Kärcher. 1986. Documentation of the German grammar. ESPRIT ACORD project 393, Deliverable Task 1.4. Stuttgart: Institut für Maschinelle Sprachverarbeitung, University of Stuttgart.
- Niño, Maria-Eugenia. 1995. The multiple expression of inflectional information and grammatical architecture. Paper presented at the Paris Syntax and Semantics Conference, Oct. 12–14, 1995. Stanford, California: Stanford University Department of Linguistics MS.
- van Riemsdijk, Henk. 1983. The case of German adjectives. In *Linguistic Categories: Auxiliaries and Related Puzzles*, ed. by Frank Heny and Barry Richards, 223–52. Dordrecht: D. Reidel.
- Ritter, Elizabeth. 1986. NSO noun phrases in Modern Hebrew. *NELS* 17.521–37.
- Ritter, Elizabeth. 1988. A head-movement approach to construct-state noun phrases. *Linguistics* 26.909–29.
- Ritter, Elizabeth. 1991. Two functional categories in noun phrases: evidence from Modern Hebrew. *Syntax and Semantics. Vol. 5: Perspectives on Phrase Structure: Heads and Licensing*, ed. by Susan D. Rothstein, 37–62. San Diego: Academic Press.
- Sadler, Louisa. 1997. Clitics and the structure-function mapping. Paper presented at LFG97, University of California, San Diego, June 19-21, 1997. On-line, The University of Essex: <http://clwww.essex.ac.uk/louisa/>.
- Sells, Peter. 1995. Korean and Japanese morphology from a lexical perspective. *Linguistic Inquiry* 26.277–325.
- Simpson, Jane. 1991. *Warlpiri Morpho-Syntax: A Lexicalist Approach*. Kluwer, Dordrecht.
- Spencer, Andrew. 1995. Incorporation in Chukchi. *Language* 71.439–89.
- Spencer, Andrew. 1997. The redundancy of lexical categories and its significance for morphology. Paper presented at the Workshop on the Place of Morphology in Linguistic Theory, LFG97, University of California, San Diego, June 19-21, 1997.
- Sproat, Richard. 1985. Welsh syntax and VSO structure. *Natural Language & Linguistic Theory* 2.173–116.
- Zaenen, Annie and Ronald M. Kaplan. 1995. Formal devices for linguistic generalizations: West Germanic word order in LFG. In *Formal Issues in Lexical-Functional Grammar*, ed. by Mary Dalrymple, Ronald M. Kaplan, John T. Maxwell III, and Annie Zaenen, 215–39. Stanford, California: CSLI Publications.
- Zucchi, Alessandro. 1993. *The Language of Propositions and Events*. Dordrecht: Kluwer Academic Publishers.